

## **36V, 0.7A, Synchronous Step-Down Converter**

### **Evaluation Board**

#### ***General Description***

The Evaluation Board demonstrates the RTQ2130B-50 to be designed for a 5V/0.7A output from a 7V to 25V input at 2.1MHz switching frequency. The wide input range makes it suitable for automotive systems and car camera module. The RTQ2130B-50 provides complete protection functions such as input undervoltage lockout, output undervoltage protection, overcurrent protection, and thermal shutdown. Cycle-by-cycle current limit provides protection against shorted outputs and soft-start eliminates input current surge during start-up.

### **Table of Contents**

General Description .....	1
Performance Sepcification Summary .....	2
Power-up Procedure .....	2
Detailed Description of Hardware .....	3
Bill of Materials.....	5
Typical Applications .....	6
Evaluation Board Layout.....	9
More Information.....	13
Important Notice for Richtek Evaluation Board.....	13

## Performance Specification Summary

Summary of the RTQ2130B-50 Evaluation Board performance specification is provided in Table 1. The ambient temperature is 25°C.

Table 1. RTQ2130B-50 Evaluation Board Performance Specification Summary

Specification	Test Conditions	Min	Typ	Max	Unit
<b>Input Voltage Range</b>	$V_{OUT} = 5V$	7	--	25	V
<b>Output Current</b>		0	--	0.7	A
<b>Default Output Voltage</b>		--	5	--	V
<b>Operation Frequency</b>		--	2100	--	kHz
<b>Output Ripple Voltage</b>	$I_{OUT} = 0.7A$	--	10	--	mVp-p
<b>Line Regulation</b>	$I_{OUT} = 0.7A, V_{IN} = 7V \text{ to } 25V$	--	$\pm 1\%$	--	--
<b>Load Regulation</b>	$V_{IN} = 12V, I_{OUT} = 0.001A \text{ to } 0.7A$	--	$\pm 1\%$	--	--
<b>Load Transient Response</b>	$I_{OUT} = 0A \text{ to } 0.7A, \text{ Slew rate} = 0.7A/\mu s$	--	$\pm 5\%$	--	--
<b>Maximum Efficiency</b>	$V_{IN} = 12V, V_{OUT} = 5V, I_{OUT} = 700mA$	--	89.7%	--	--

## Power-up Procedure

### Suggestion Required Equipment

- RTQ2130B Evaluation Board
- DC power supply capable of at least 36V and 1A
- Electronic load capable of 6A
- Function Generator
- Oscilloscope

### Quick Start Procedure

The Evaluation Board is fully assembled and tested. Follow the steps below to verify board operation. Caution: Do not turn on supplies until all connections are made. Note: When measuring the output voltage ripple, care must be taken to avoid a long ground lead on the oscilloscope probe. Measure the output voltage ripple by touching the probe tip and ground ring directly across the last output capacitor.

### Proper measurement equipment setup and follow the procedure below.

- 1) With power off, connect the input power supply to VIN and GND pins.
- 2) With power off, connect the electronic load between the VOUT and nearest GND pins.
- 3) Turn on the power supply at the input. Make sure that the input voltage does not exceeds 36V on the Evaluation Board.
- 4) Check for the proper output voltage using a voltmeter.
- 5) Once the proper output voltage is established, adjust the load within the operating ranges and observe the output voltage regulation, ripple voltage, efficiency and other performance.

**Detailed Description of Hardware**

**Headers Description and Placement**

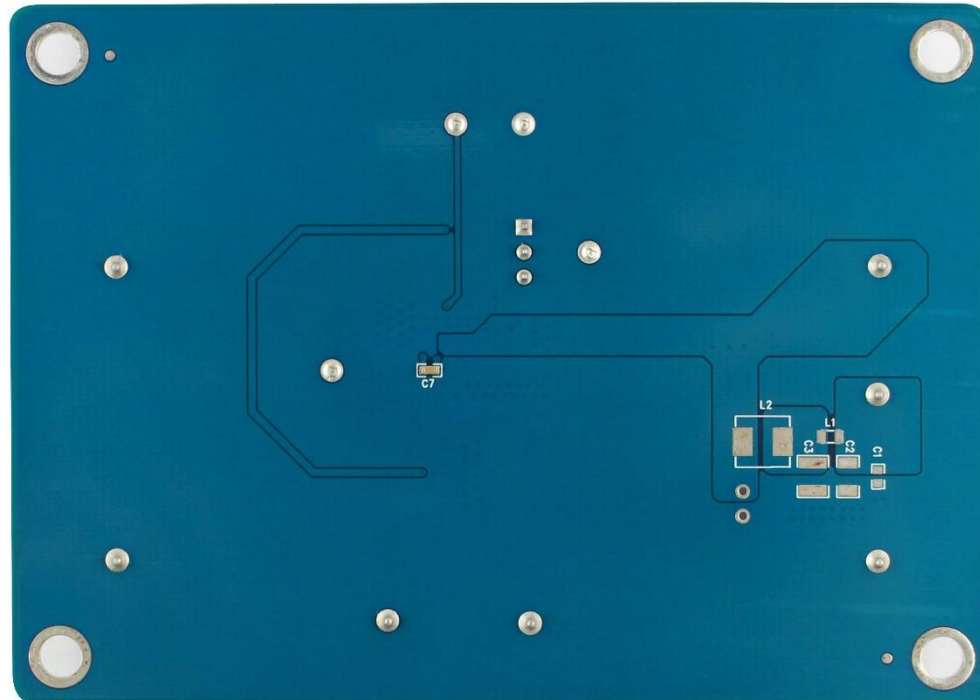
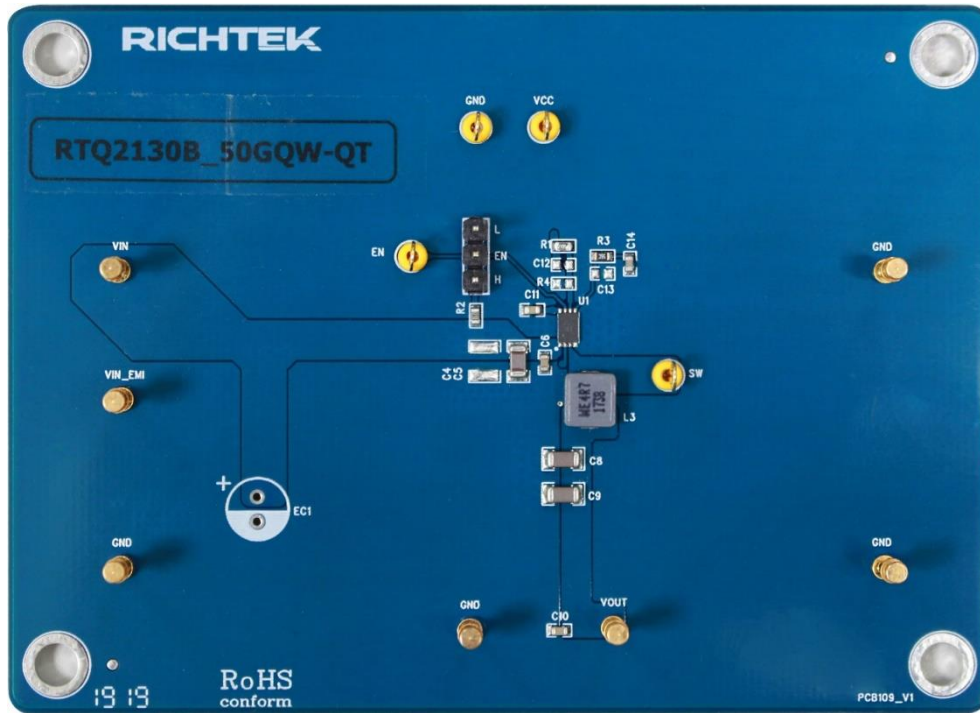

Carefully inspect all the components used in the EVB according to the following Bill of Materials table, and then make sure all the components are undamaged and correctly installed. If there is any missing or damaged component, which may occur during transportation, please contact our distributors or e-mail us at [evb\\_service@richtek.com](mailto:evb_service@richtek.com).

## Enable

For automatic start-up, the EN pin, with high-voltage rating, can be connected to the input voltage by a 100k $\Omega$  through the JP1. Shutdown the converter by short EN pin to GND through the JP1.

## Test Points

The EVB is provided with the test points and pin names listed in the table below.

Test Point/ Pin Name	Function
<b>VIN</b>	Input voltage positive connection. The power supply must be connected to input connectors, VIN and GND.
<b>EN</b>	Enable test point. The test point can be used to measure the enable signal.
<b>VOUT</b>	Output voltage connection. The load must be connected to output connectors, VOUT and GND.
<b>JP1</b>	EN jumper. Connect EN to ground to disable, connect EN to logic high to enable.
<b>GND</b>	Ground. Input/Output voltage return connection.
<b>SW</b>	Switch node test point. The test point can be used to measure the switching node.
<b>VIN_EMI</b>	Input voltage node before EMI solution. Optional for EMI requirement.
<b>VCC</b>	Linear regulator output test point. The test point can be used to measure the output node of the internal regulator.

**Bill of Materials**

VIN = 12V, VOUT 5V / 0.7A, fsw = 2100kHz						
Reference	Count	Part Number	Value	Description	Package	Manufacturer
U1	1	RTQ2130-50BGQW-QT	RTQ2130B-50	Step-Down Converter	WDFN-8SL 2x3	RICHTEK
C1, C2, C3, EC1, C4	5	NA	NA	Optional for EMI requirement	NA	--
C5	1	GCM31CR71H225KA	2.2 $\mu$ F	Capacitor, ceramic, 50V, X7R, $\pm$ 10%	1206	MURATA
C6, C7, C10	3	CGA3E2X7R1H104K	0.1 $\mu$ F	Capacitor, ceramic, 50V, X7R, $\pm$ 10%	0603	TDK
C8, C9	2	GCM31CC71E106KA	10 $\mu$ F	Capacitor, ceramic, 25V, X7S, $\pm$ 10%	1206	MURATA
C11	1	GCM188R71C105KA	1 $\mu$ F	Capacitor, ceramic, 16V, X7R, $\pm$ 10%	0603	MURATA
C12	1	NA	NA	Optional	NA	--
C13	1	NA	NA	Optional	NA	--
C14	1	GCE188R71H152KA	1.5nF	Capacitor, ceramic, 50V, X7R, $\pm$ 10%	0603	MURATA
L1, L2	2	NA	NA	Optional for EMI requirement	NA	--
L3	1	WE-74437324047	4.7 $\mu$ H	Inductor, SMT, ISAT = 4A, 95m $\Omega$	4.45mmx4.06mmx1.8mm	Wurth Elektronik
R1	1	NA	short	NA	0603	--
R2	1	WR06X1003	100k $\Omega$	Resistor, chip, 1/10W, 1%	0603	WALSIN
R3	1	WR06X3742	37.4k $\Omega$	Resistor, chip, 1/10W, 1%	0603	WALSIN
R4	1	NA	NA	NA	NA	--

**Typical Applications**

**EVB Schematic Diagram**

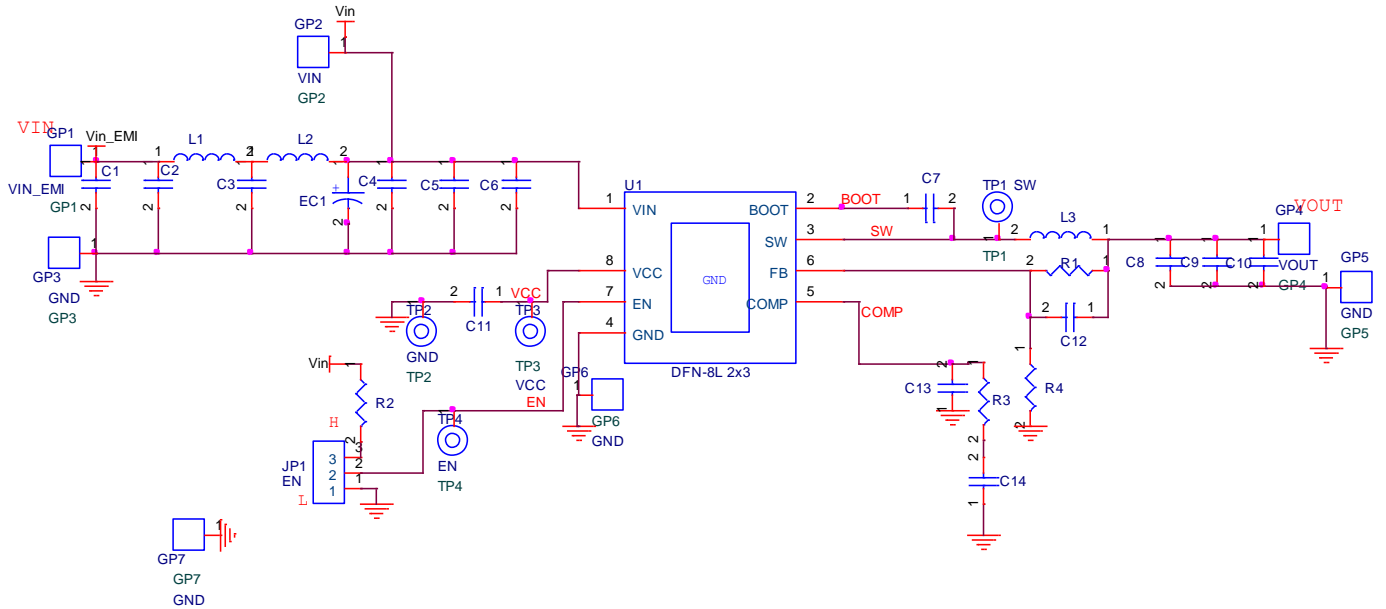

1. The capacitance values of the input and output capacitors will influence the input and output voltage ripple.
2. MLCC capacitors have degrading capacitance at DC bias voltage, and especially smaller size MLCC capacitors will have much lower capacitance.

Measure Result

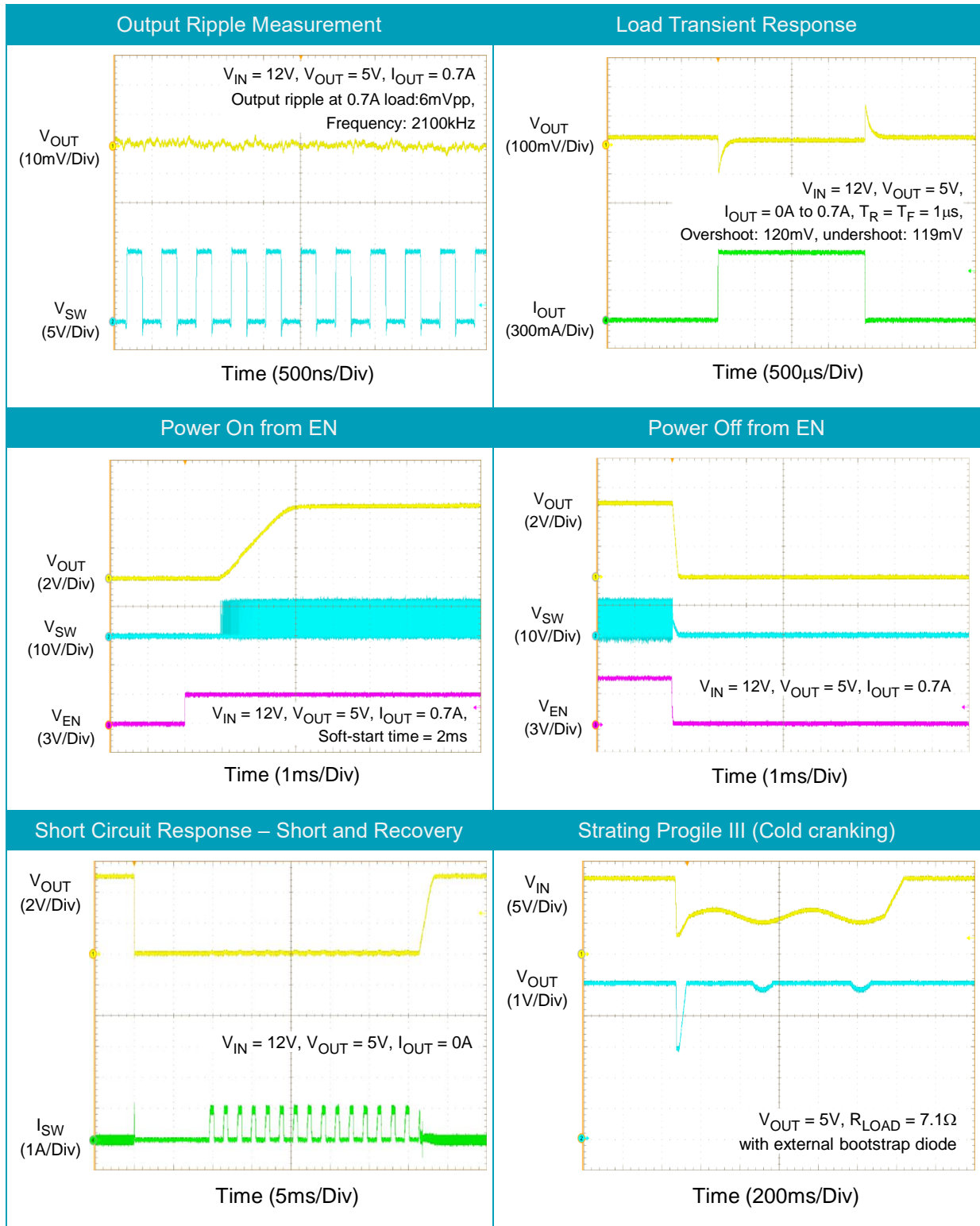

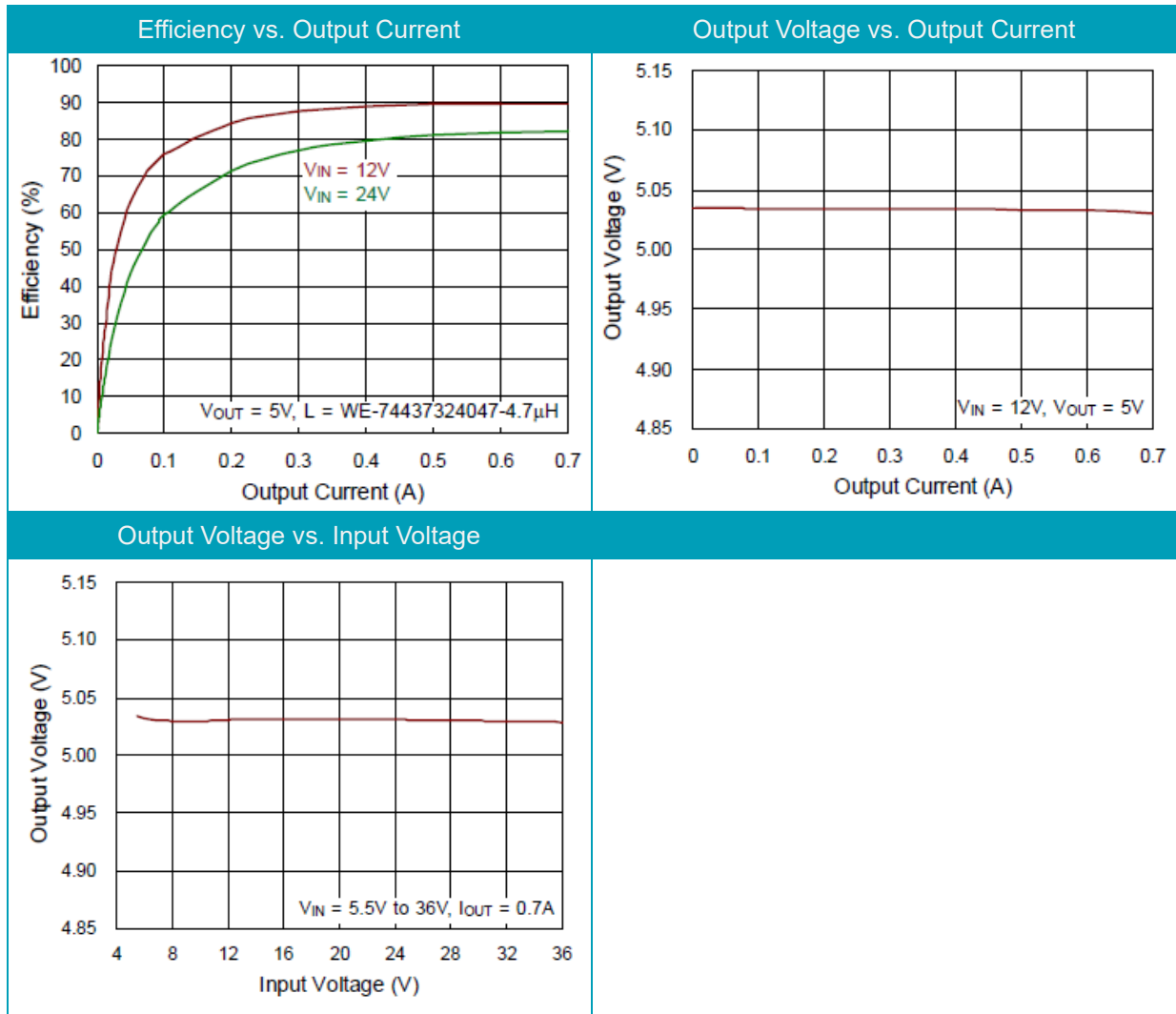

Note: When measuring the input or output voltage ripple, care must be taken to avoid a long ground lead on the oscilloscope probe. Measure the output voltage ripple by touching the probe tip directly across the output capacitor.



**Evaluation Board Layout**

Figure 1 to Figure 4. are RTQ2130B Evaluation Board layout. This board size is 110mmx80mm and is constructed on four-layer PCB with 1 OZ. Cu on the outer layers and 1 OZ. Cu in the inner layers.

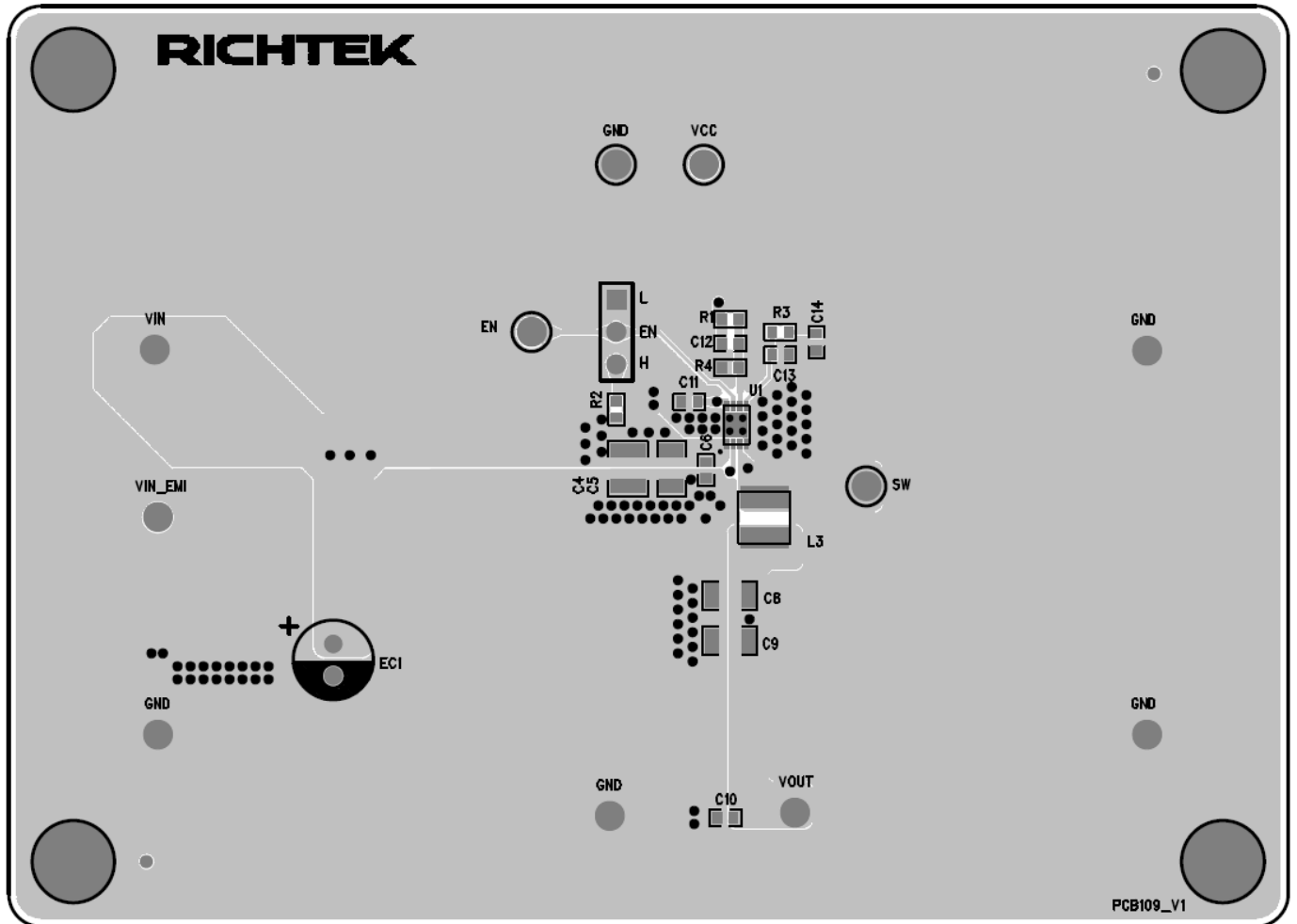

Figure 1. Top View (1<sup>st</sup> layer)

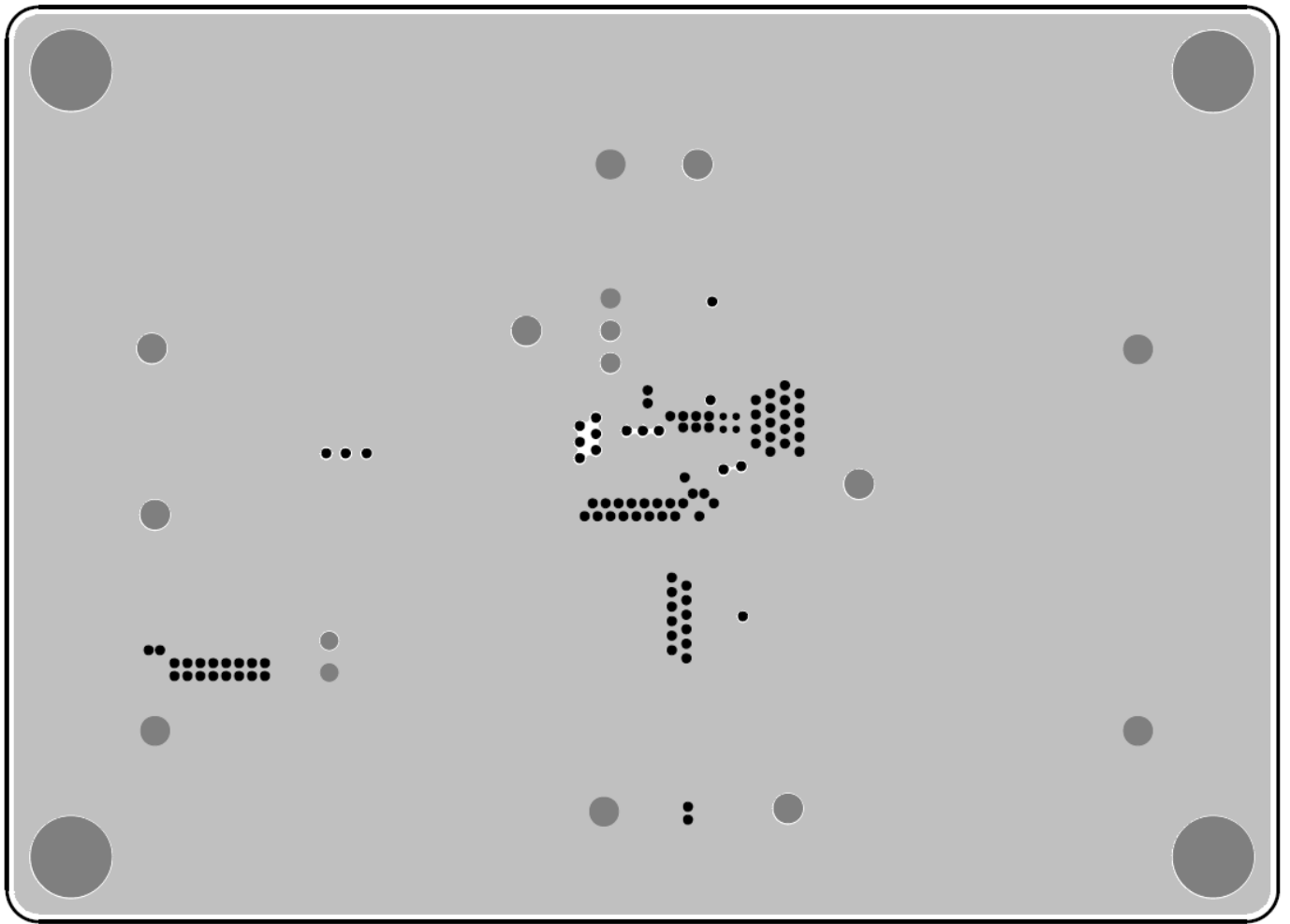

Figure 2. PCB Layout—Inner Side (2<sup>nd</sup> Layer)

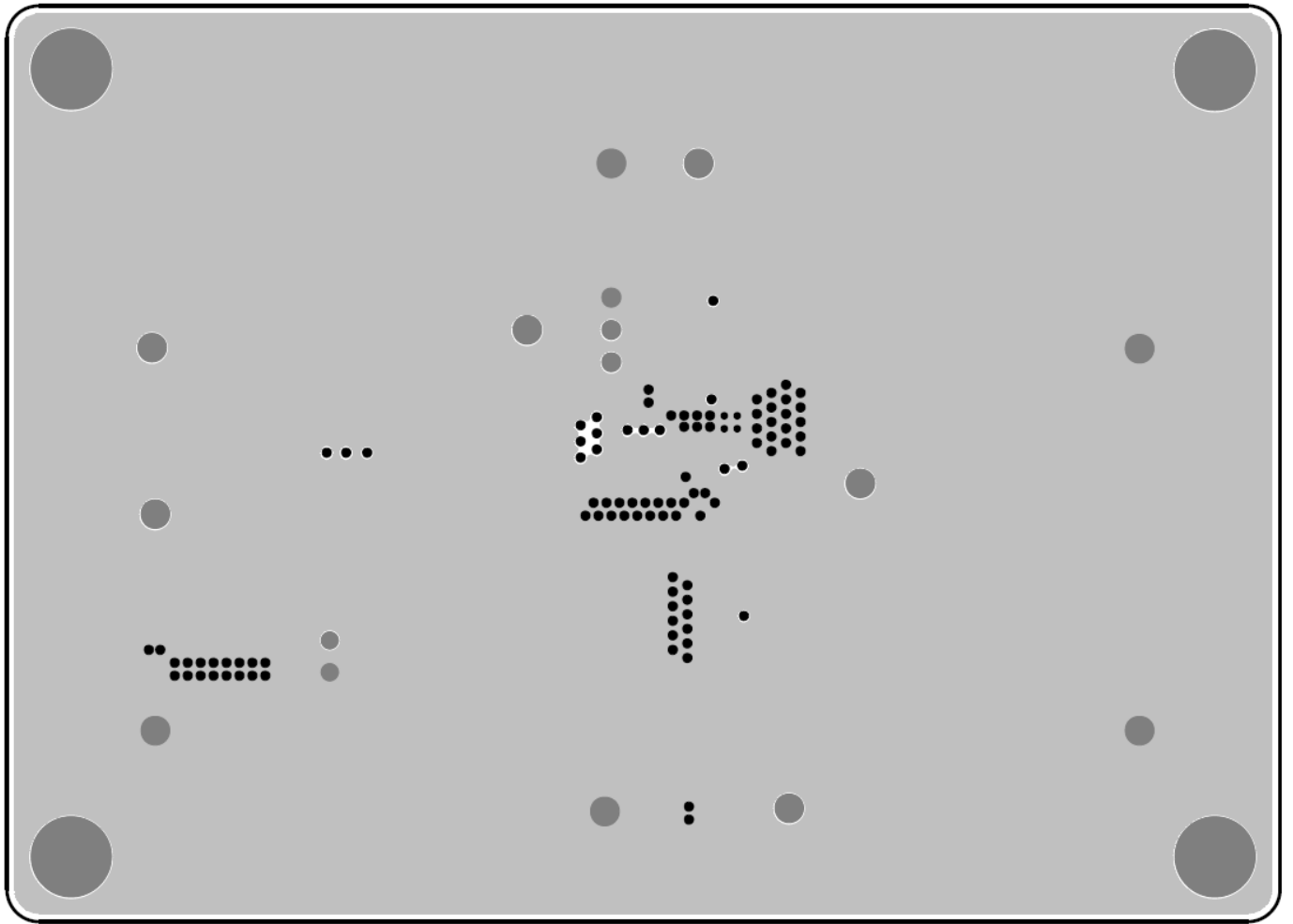

Figure 3. PCB Layout—Inner Side (3<sup>rd</sup> Layer)

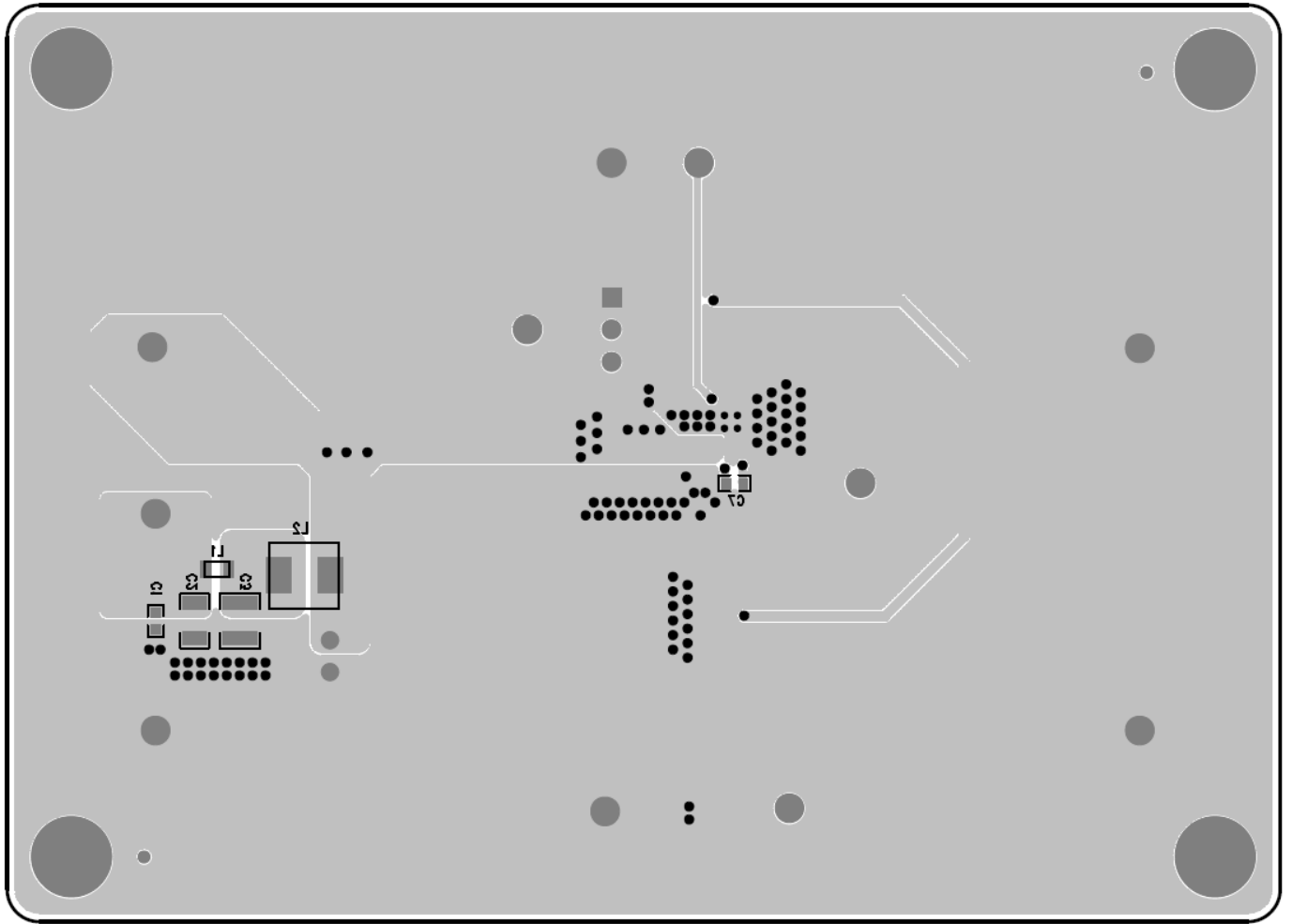

Figure 4. Bottom View (4<sup>th</sup> Layer)

## ***More Information***

For more information, please find the related datasheet or application notes from Richtek website  
<http://www.richtek.com>.

## ***Important Notice for Richtek Evaluation Board***

THIS DOCUMENT IS FOR REFERENCE ONLY, NOTHING CONTAINED IN THIS DOCUMENT SHALL BE CONSTRUED AS RICHTEK'S WARRANTY, EXPRESS OR IMPLIED, UNDER CONTRACT, TORT OR STATUTORY, WITH RESPECT TO THE PRESENTATION HEREIN. IN NO EVENT SHALL RICHTEK BE LIABLE TO BUYER OR USER FOR ANY AND ALL DAMAGES INCLUDING WITHOUT LIMITATION TO DIRECT, INDIRECT, SPECIAL, PUNITIVE OR CONSEQUENTIAL DAMAGES.